

DECAL KIT "USA"
 SCHILDERSATZ "USA"
 JEU DE PLAQUES "USA"

from No / up to No
 WFN5RUG###2036145

Figure
 Bild 99707792831
 Figure

TADANO
 2830-21

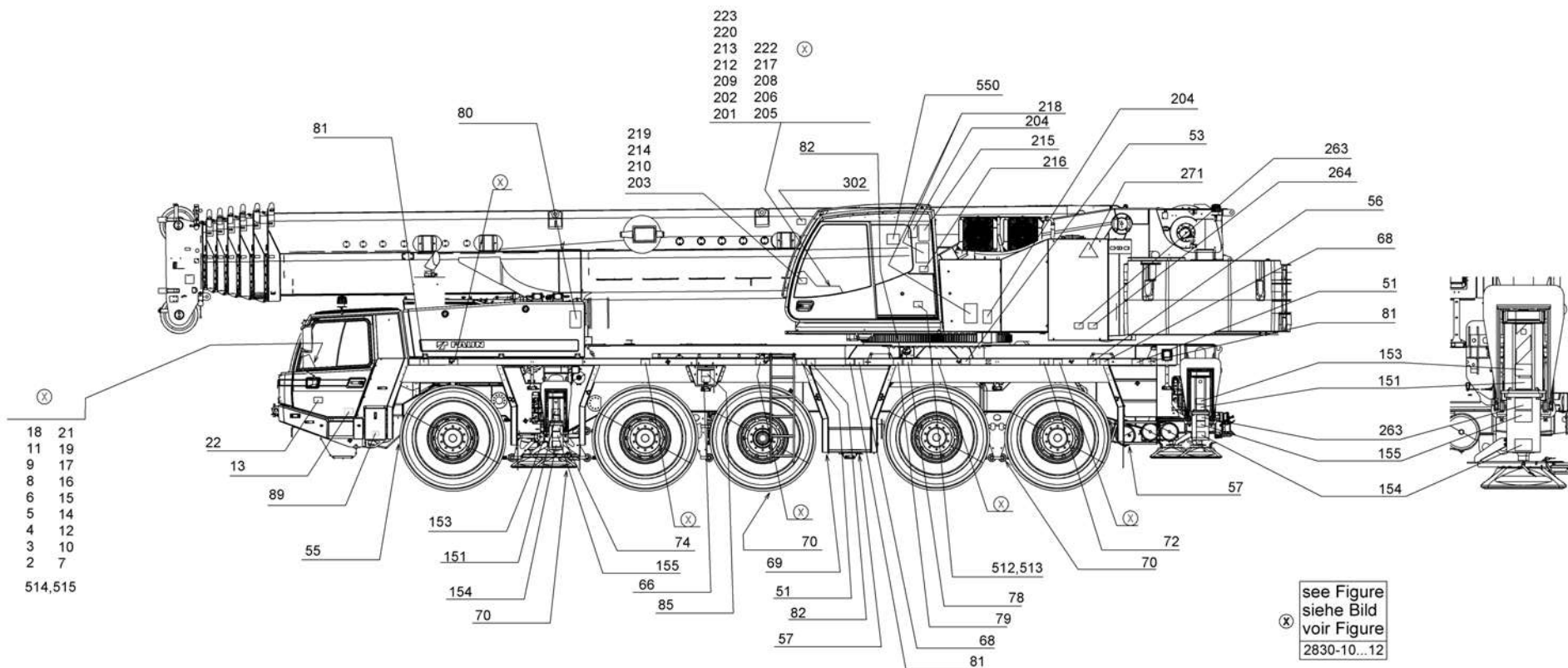

DECAL KIT "USA"
SCHILDERSATZ "USA"
JEU DE PLAQUES "USA"

from No / up to No
WFN5RUG###2036145

Figure
Bild 99707792831
Figure

TADANO
2830-21

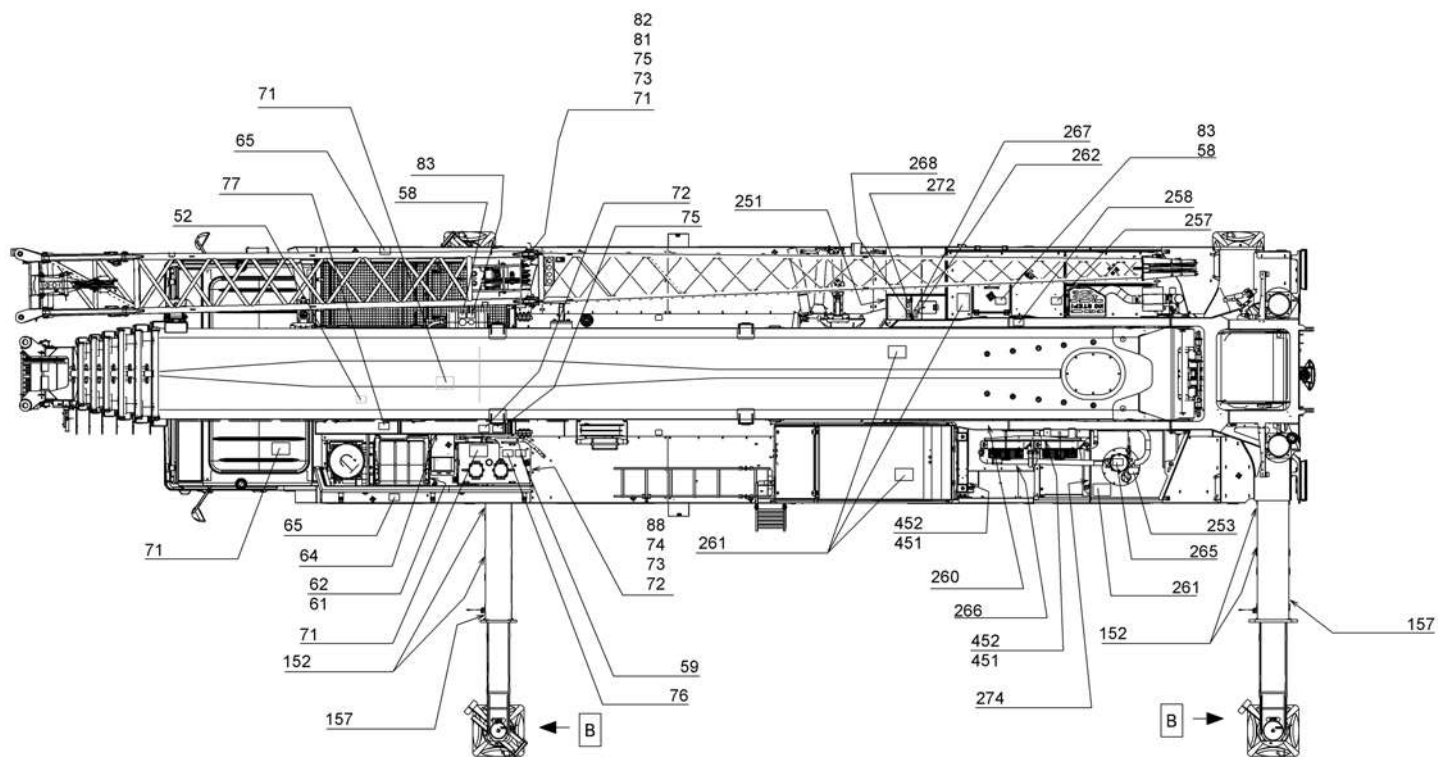

DECAL KIT "USA"
SCHILDERSATZ "USA"
JEU DE PLAQUES "USA"

from No / up to No
WFN5RUG###2036145

Figure
Bild 99707792831
Figure

TADANO
2830-21

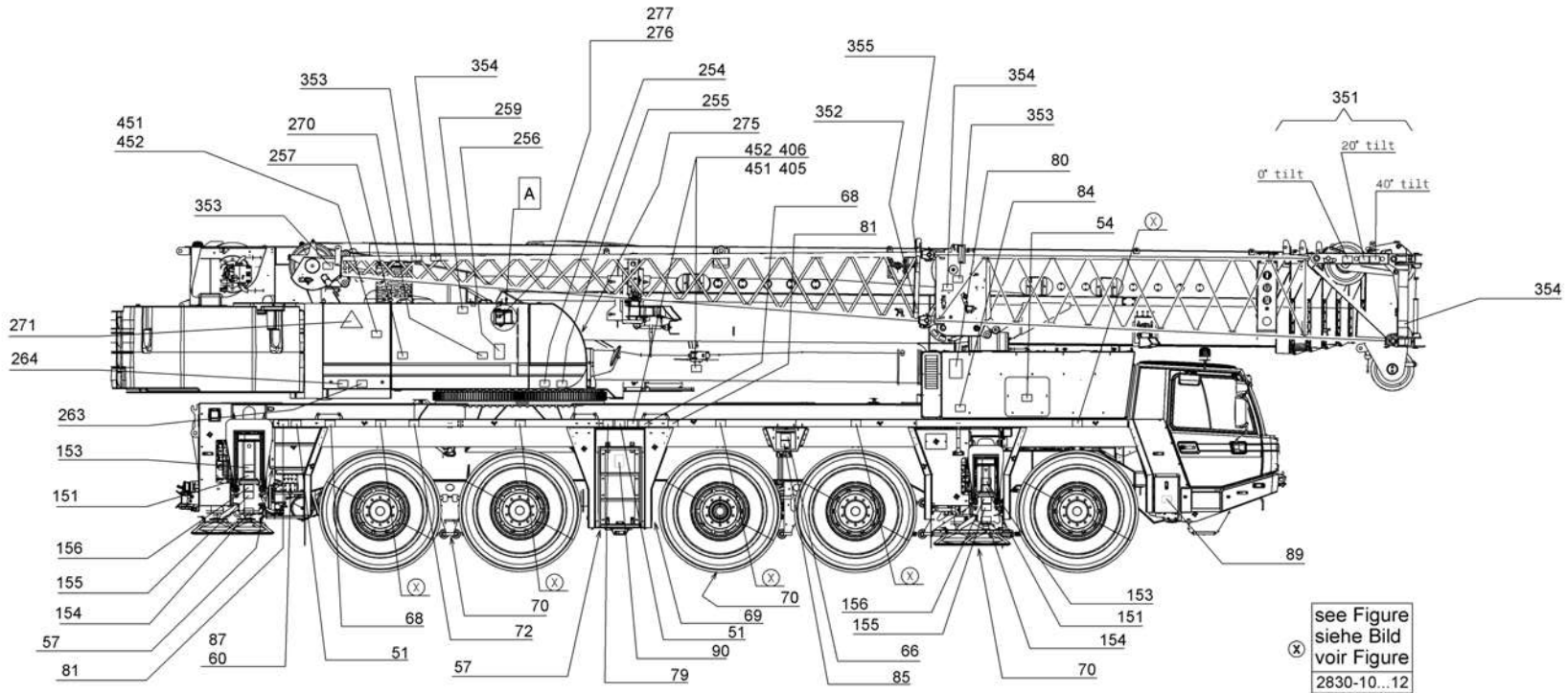

A

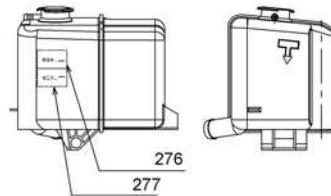

DECAL KIT "USA"
SCHILDERSATZ "USA"
JEU DE PLAQUES "USA"

from No / up to No
WFN5RUG###2036145

Figure
Bild 99707792831
Figure

 **TADANO**
2830-21

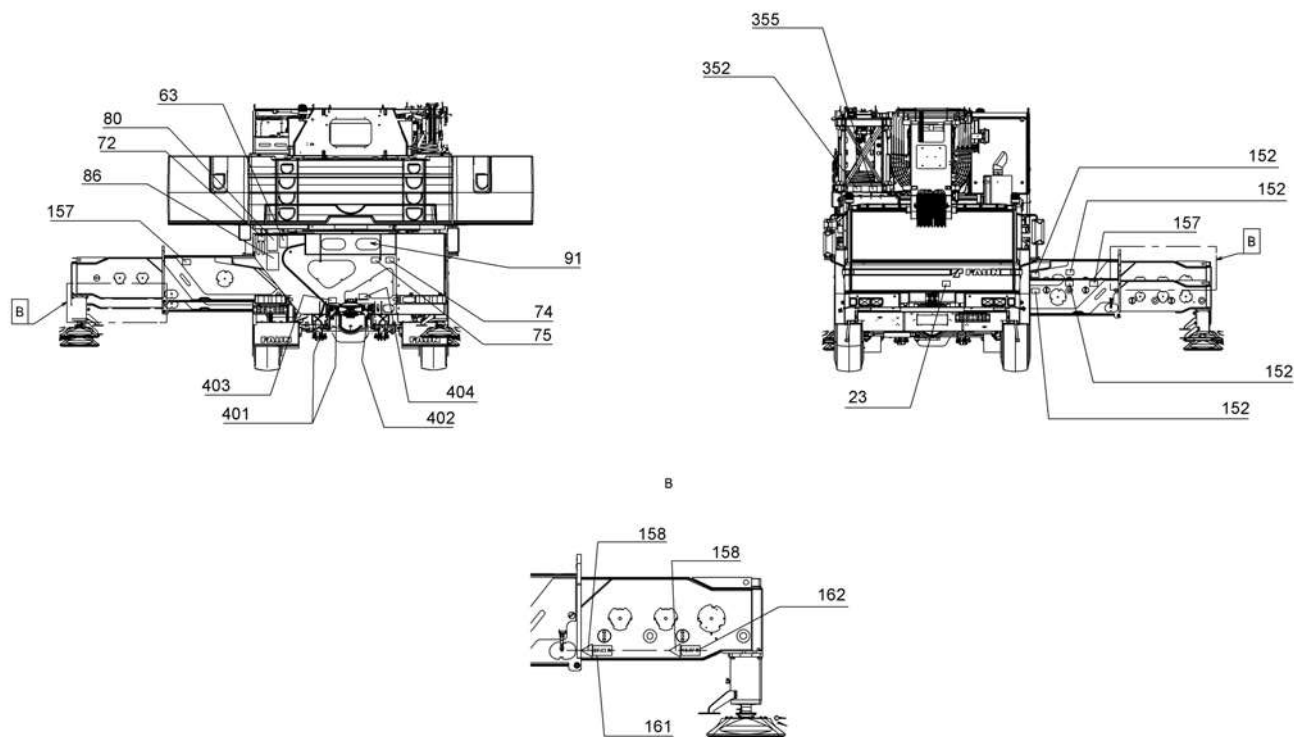

DECAL KIT "USA"
SCHILDERSATZ "USA"
JEU DE PLAQUES "USA"

from No / up to No
WFN5RUG###2036145

Figure
Bild 99707792831
Figure

TADANO
2830-21

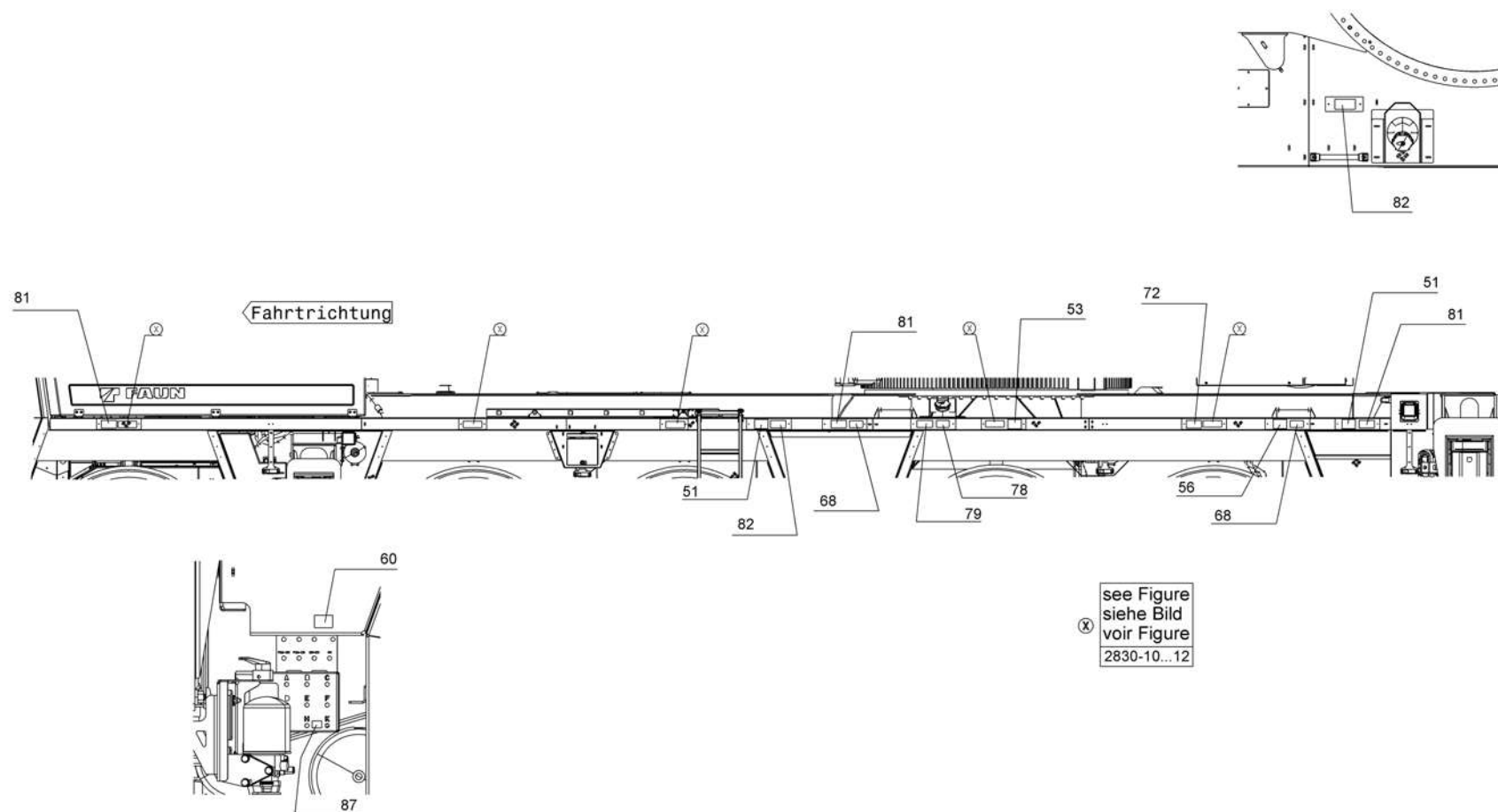

DECAL KIT "USA"
SCHILDERSATZ "USA"
JEU DE PLAQUES "USA"





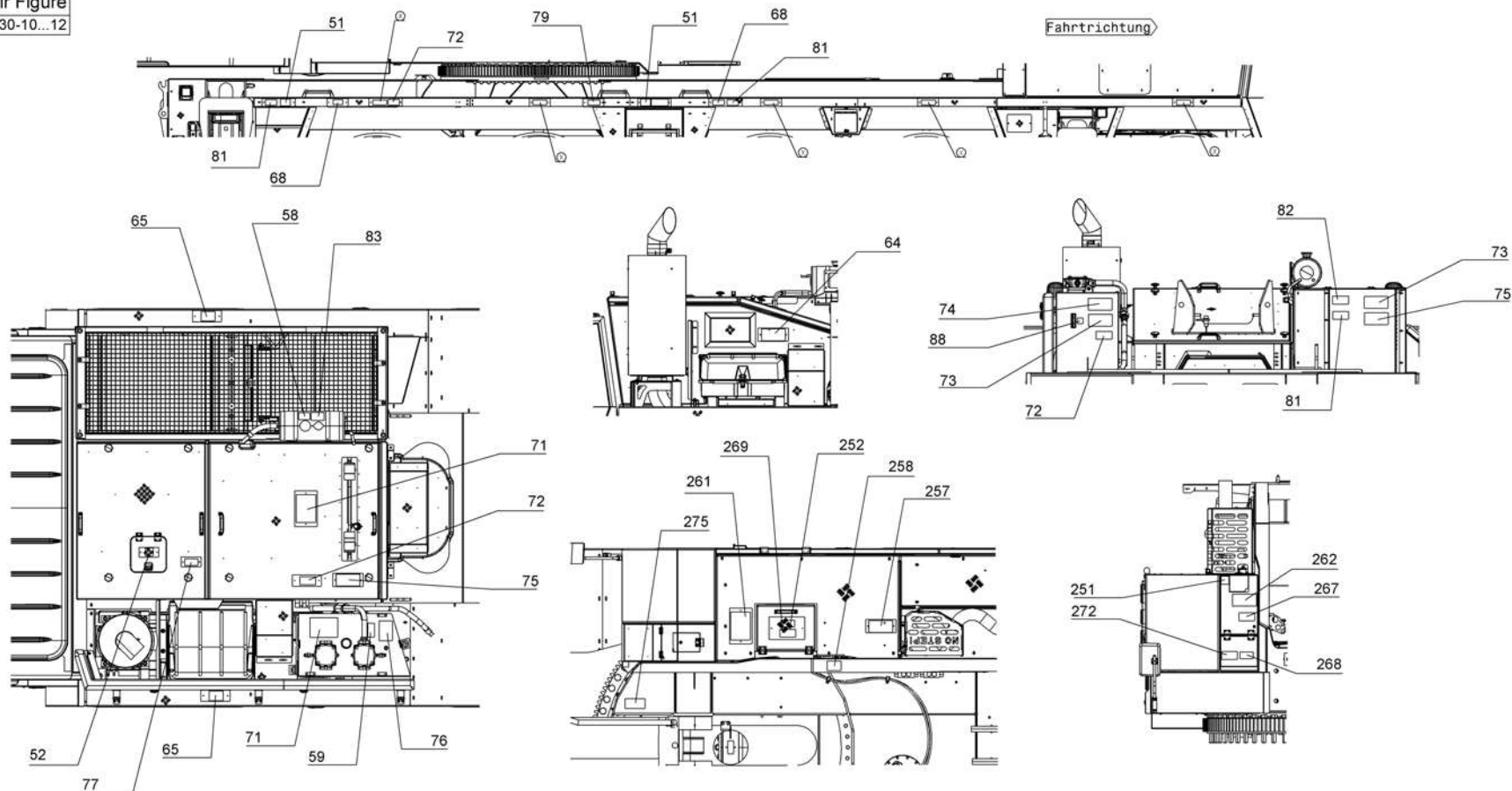

from No / up to No
WFN5RUG###2036145

Figure
Bild 99707792831
Figure

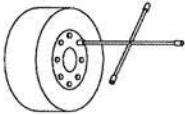
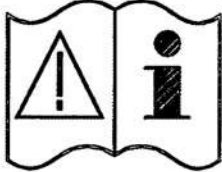
TADANO
2830-21

see Figure
siehe Bild
voir Figure
2830-10...12

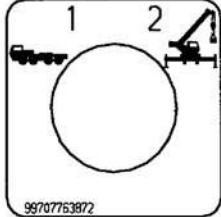
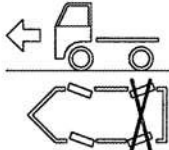
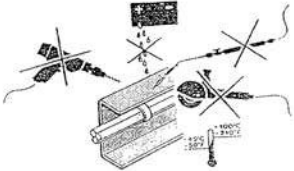
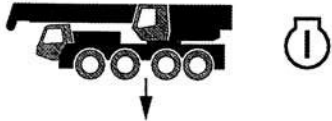

<p>NOTICE</p>  <p>CHECK WHEEL LUGNUTS PERIODICALLY ACCORDING TO WORKING CONDITIONS READ INSTRUCTIONS BEFORE SERVICING</p> <p>7741358</p> <p>2</p>	 <p>SEE OPERATORS MANUAL</p> <p>7741359</p> <p>3</p>	 <p>7757221</p> <p>4,201</p>	 <p>7741364</p> <p>ENGINE SPEED CONTROL</p> <p>5,202</p>
 <p>PARKING BRAKE</p> <p>7757220</p> <p>6</p>	<p>WARNING</p>  <p>HAZARDOUS CONDITION CAN CAUSE VEHICLE HANDLING PROBLEMS DIFFERENTIAL LOCK MUST ONLY BE ENGAGED IN OFF - ROAD ROUGH TERRAIN CONDITIONS</p> <p>7757245</p> <p>7</p>	 <p>99707763972</p> <p>14</p>	<p>WARNING</p>  <p>7741385</p> <p>LOCK THE REAR AXLE STEERING SYSTEM WHEN TRAVELING ON ROAD OR WITH DOLLY</p> <p>8</p>
<p>CAUTION</p>  <p>PLASTIC BRAKE SYSTEM PIPES BE CAREFUL WHEN WELDING DRILLING AND MOUNTING</p> <p>7741366</p> <p>9</p>	<p>CAUTION</p>  <p>VEHICLE LOWERS ONLY WHEN ENGINE IS RUNNING</p> <p>7757244</p> <p>10</p>	<p>WARNING</p>  <p>DO NOT STAY UNDER OR ON VEHICLE WHEN LOWERING</p> <p>7741356</p> <p>11</p>	<p>CAUTION</p>  <p>DO NOT REMAIN IN CAB WHEN CRANE IS OPERATING</p> <p>7757246</p> <p>12</p>







<p>CAUTION</p>  <p>ENGAGE PARKING HANDBRAKE BEFORE LEAVING CAB.</p> <p>7741361</p> <p>13</p>	<p>WARNING</p> <p>STOP! NO ACCESS FOR UNAUTHORIZED PERSONNEL</p>  <p>99707757258</p> <p>51</p>	<p>CAUTION</p> <ol style="list-style-type: none"> BEFORE TRAVEL : -POSITION REAR WHEELS STRAIGHT AHEAD. STEER LAMP MUST NOT BE ON -SET SWING LOCK LEVER TO "LOCK". SET GEAR SHIFT LEVER TO N. WHEN STARTING ENGINE. REAR AXLE STEERING MUST ONLY BE ENGAGED IN FIRST OR REVERSE GEAR AND TRAVEL WITHOUT DOLLY. SET PARKING BRAKE AND SHUT OFF ENGINE BEFORE LEAVING CAB. <p>99707792831</p> <p>16</p>	 <p>-2878-149 0015</p> <p>52,251</p>
<p>NOTICE</p> <p>TEST CONNECTOR M5 FOR STEERING SYSTEM SEE OPERATORS MANUAL FOR INSTRUCTIONS</p> <p>99707757302</p> <p>56</p>	<p>24V DC</p> <p>7757240</p> <p>17,209</p>	<p>12V DC</p> <p>7757241</p> <p>23,208</p>	 <p>AIR BRAKE PRESSURE: 120 - 145 PSI</p> <p>99707780263</p> <p>15</p>
 <p>220</p>	<p>WARNING</p> <p>INSTALL ALL PINS IN EACH OUTRIGGER, OUTRIGGER PAD AND JIB BEFORE STARTING TO TRAVEL</p> <p>7741394</p> <p>151</p>	<p>OPERATING AIR PRESSURE 180 PSI</p> <p>99707792830</p> <p>57</p>	<p>NOTICE</p> <p>COOLING FLUID SEE OPERATORS MANUAL FOR INSTRUCTIONS</p> <p>7741396</p> <p>58,252</p>

DECAL KIT "USA"
 SCHILDERSATZ "USA"
 JEU DE PLAQUES "USA"

from No / up to No
 WFN5RUG###2036145

Figure
 Bild 99707792831
 Figure

TADANO
 2830-21

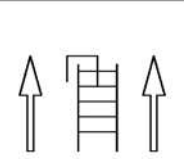

<p>NOTICE HYDRAULIC FLUID SEE OPERATORS MANUAL FOR INSTRUCTIONS</p> <p>7741397</p> <p>59,253</p>	<p>NOTICE TEST CONNECTORS M4 FOR HYDRAULIC SYSTEM SEE OPERATORS MANUAL FOR INSTRUCTIONS</p> <p>99707785926</p> <p>60</p>	<p>EXTERNAL BATTERY STARTING PLUG SOCKET 24V / DC</p> <p>7741391</p> <p>61,254</p>	<p>BATTERY CHARGING PLUG SOCKET 24V / DC</p> <p>7741392</p> <p>62,255</p>
<p>FASTEN SEAT BELT</p> <p>7757227</p> <p>18</p>	<p> DANGER</p> <p>MOVING OUTRIGGER BOXES CAN CAUSE SEVERE INJURY DO NOT INSERT FINGERS</p> <p>7741389</p> <p>152</p>	<p> DANGER !</p> <p>ELECTROCUTION HAZARD CAN CAUSE SEVERE INJURY OR DEATH KEEP MINIMUM SEPARATION DISTANCE FROM POWER LINES PER LOCAL / STATE / FEDERAL REGULATIONS</p>	
<p> CAUTION</p> <p>HAZARDOUS CONDITION CAN CAUSE BURN INJURY DO NOT TOUCH HOT EXHAUST PIPE KEEP CLEAR WHEN ENGINE IS RUNNING</p> <p>7757269</p> <p>64,257</p>	<p> WARNING</p> <p> DO NOT STEP HERE</p> <p>7757214</p> <p>65,258</p>	<p> PELIGRO !</p> <p>MANTENGA DISTANCIA PRUDENCIAL DELANTE DE LOS CABLES DE ALTA TENSION</p> <p>7745634</p> <p>63,204,256</p>	<p> LADDER POSITION</p> <p>99707757224</p> <p>259</p>

DECAL KIT "USA"
 SCHILDERSATZ "USA"
 JEU DE PLAQUES "USA"

from No / up to No
 WFN5RUG###2036145

Figure
 Bild 99707792831
 Figure

TADANO
 2830-21

	<p>NOTICE TEST CONNECTORS M1 + M2 FOR STEERING SYSTEM SEE OPERATORS MANUAL FOR INSTRUCTIONS <small>99707757000</small></p> <p>55</p>	<p>OUTRIGGER CONTROL BOX</p> <p><small>7757213</small></p> <p>66</p>	<p>FREE <small>7757266</small>  SWING  LOCKED</p> <p>206</p>
			<p>NOTICE TEST CONNECTORS M3 FOR HYDRAULIC SYSTEM SEE OPERATORS MANUAL FOR INSTRUCTIONS <small>99707780259</small></p> <p>54</p>
<p>NO STEP</p> <p><small>7757257</small></p> <p>20,71,211,261,301</p>	<p>HANDHOLD</p> <p><small>7757226</small></p> <p>68</p>	<p> DANGER NEVER EXTEND BLIND SIDE OUTRIGGERS WITHOUT A SPOTTER <small>7757239</small></p> <p>210</p>	<p>TEST CONNECTORS M4 FOR HYDRAULIC SYSTEM SEE OPERATORS MANUAL FOR INSTRUCTIONS <small>99707785926</small></p> <p>53</p>

DECAL KIT "USA"
 SCHILDERSATZ "USA"
 JEU DE PLAQUES "USA"

from No / up to No
 WFN5RUG###2036145

Figure
 Bild 99707792831
 Figure

TADANO
 2830-21







<p>CAUTION</p> <p>BEFORE CHANGING OVER TO OPERATION CONTROLLED FROM THE SUPERSTRUCTURE, MAKE SURE THAT: 1) TRANSMISSION IS IN NEUTRAL POSITION, 2) HANDBRAKES ARE ENGAGED.</p> <p>99707792800</p> <p>21</p>	<p>110 lbs</p> <p>99707787917</p> <p>89</p>	<p>99707749823</p> <p>212</p>	<p>CAUTION</p> <p>DO NOT USE OXYGEN ! DO NOT OPERATE UNIT WITHOUT PROPER NITROGEN GAS PRESSURE RELEASE ALL HYDRAULIC AND GAS PRESSURE BEFORE DISASSEMBLING UNIT SEE SERVICE INSTRUCTIONS FOR ADDITIONAL INFORMATION</p> <p>7757251</p> <p>70,260</p>
<p>99707776041</p> <p>203</p>	<p>WARNING</p> <p>STEERING FUNCTIONS ONLY WHILE ENGINE IS RUNNING</p> <p>7757267</p> <p>205</p>	<p>WARNING</p> <p>HAZARD CAN CAUSE INJURY KEEP CLEAR OF OUTRIGGER WHILE CRANE IS OPERATING</p> <p>7757334</p> <p>154</p>	<p>WARNING</p> <p>HAZARD CAN CAUSE INJURY KEEP CLEAR OF CRANE WHILE SWINGING OR TRAVELING</p> <p>7757335</p> <p>72</p>
<p>WARNING</p> <p>KEEP CLEAR OF MOVING OUTRIGGER TO PREVENT BODILY INJURY.</p> <p>7757336</p> <p>155</p>	<p>WARNING</p> <p>HAZARDOUS CONDITION CAN CAUSE SEVERE INJURY ENSURE JIB PIVOT PINS ARE INSTALLED AT BOOM HEAD BEFORE DISCONNECTING JIB FROM STOWING BRACKET</p> <p>7757337</p> <p>352</p>	<p>WARNING</p> <p>HAZARDOUS CONDITION CAN CAUSE SEVERE INJURY USE A TAGLINE TO PREVENT RAPID SURING OF JIB FROM BOOM WHEN JIB IS RELEASED AT STOWING BRACKET</p> <p>7757338</p> <p>353</p>	<p>DANGER</p> <p>KEEP CLEAR OF LOWERING OR RAISING BOOM TO AVOID SERIOUS INJURY.</p> <p>7757339</p> <p>73,262,302</p>



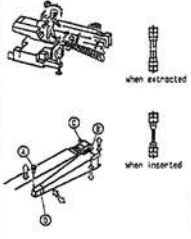
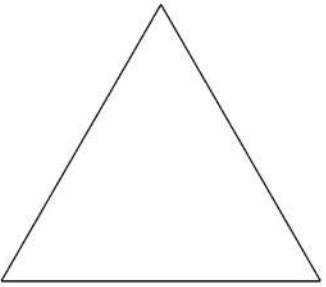

DECAL KIT "USA"
 SCHILDERSATZ "USA"
 JEU DE PLAQUES "USA"

from No / up to No
 WFN5RUG###2036145

Figure
 Bild 99707792831
 Figure

TADANO
 2830-21

 <p>DANGER</p> <p>FALLING LOAD OR BOOM CAN CAUSE SEVERE PERSONAL INJURY OR DEATH STAY CLEAR OF LOAD, BLOCK AND BOOM</p> <p>7757340</p> <p>74,156,263</p>	 <p>DANGER</p> <p>SWINGING STRUCTURE STAY CLEAR TO PREVENT SEVERE PERSONAL INJURY OR DEATH</p> <p>7757341</p> <p>75,264</p>	<p>NOTICE HYDRAULIC FLUID ONLY</p> <p>READ OPERATORS MANUAL BEFORE SERVICING ALL CYLINDERS MUST BE RETRACTED WHEN CHECKING FLUID LEVEL</p> <p>7757342</p> <p>76,265</p>	 <p>WARNING</p> <p>ROTATING FAN KEEP HANDS AWAY STOP ENGINE TO SERVICE</p> <p>7757343</p> <p>77</p>
<p>CAUTION</p> <p>JIB HANDLING INSTRUCTIONS BEFORE OPERATING CRANE OR TRAVELLING ON ROAD, CHECK STOWING PIN (A) AND PIVOT PIN (B). JIB WILL FALL OFF IF TRAVEL IS STARTED WITH BOTH PINS OUT OF POSITION. NEVER EXTEND BOOM WHEN BOTH PINS ARE FIXED AT THE SAME TIME. THE BOOM WILL BE DAMAGED. *TO USE JIB 1. INSERT TOP AND BOTTOM PIVOT PIN (B). 2. EXTRACT STOWING PIN (A). 3. DISCONNECT ROPE SOCKET FROM ANCHOR (C). 4. TUCK AND ALIGN JIB STRAIGHT AHEAD OF BOOM AND INSERT TOP AND BOTTOM CONNECTING PINS (D). 5. JOIN ELECTRICAL CONNECTIONS FOR ANTI-TWO BLOCK ALARM DEVICE AND FIX AUXILIARY WIND LOCK. *TO STOW JIB, INSERT STOWING PIN (A) TO SECURE JIB TO BOOM AND THEN EXTRACT PIVOT PIN (B). ATTACH ROPE SOCKET TO ANCHOR (C) DAILY AFTER JIB IS COMPLETELY STOWED.</p>  <p>7757344</p> <p>354</p>	<p>DIESEL FUEL</p> <p>7757345</p> <p>78,266</p>	 <p>158</p>	<p>DANGER</p> <p>ELECTROCUTION HAZARD CAN CAUSE SERIOUS INJURY OR DEATH. NEVER OPERATE THIS CRANE WITHIN MINIMUM DISTANCE OF A POWER SOURCE OR POWER LINE, SPECIFIED BY LOCAL ORDINANCE ALWAYS NOTIFY POWER OR UTILITY COMPANY.</p> <p>THIS MACHINE IS NOT EQUIPPED WITH ANY WARNING OR INSULATING DEVICES. ALLOW FOR BOOM DEFLECTION, ELECTRICAL LINE, AND LOAD LINE SWAYING.</p> <p>NEVER OPERATE CRANE, ANY PART THEREOF OR LOAD WITHIN 20 FEET OF ANY ELECTRICAL POWER LINE OR POWER SOURCE OR SUCH DISTANCE AS IS SPECIFIED OR REQUIRED BY LOCAL OR OTHER APPLICABLE SAFETY CODES OR REGULATIONS.</p> <p>NEVER OPERATE, SERVICE OR MAINTAIN THIS CRANE WITHOUT PROPER INSTRUCTIONS. IT IS THE EMPLOYER'S RESPONSIBILITY TO PROVIDE ALL SAFETY DEVICES OR MEANS THAT ARE NECESSARY OR REQUIRED FOR ANY USE, OPERATION, SET-UP OR SERVICE.</p> <p>DANGER</p> <p>THIS MACHINE IS NOT EQUIPPED WITH ANY WARNING OR INSULATING DEVICES. EXTREME CAUTION MUST BE EXERCISED BY ALL PERSONNEL WORKING WITH AND AROUND THIS MACHINE WHEN IN THE PROXIMITY OF ENERGIZED POWER SOURCE OR POWER LINES. DEATH OR SERIOUS INJURY CAN RESULT FROM CONTACT OR INADEQUATE CLEARANCE. ALL PERSONNEL MUST BE ADEQUATELY WARNED OF SAFETY PROCEDURES.</p> <p>7757348</p>
<p>WARNING</p> <p>DO NOT OPERATE THIS CRANE UNLESS</p> <ul style="list-style-type: none"> - YOU ARE TRAINED IN ITS SAFE OPERATION - YOU KNOW AND FOLLOW THE SAFETY AND OPERATING INSTRUCTIONS CONTAINED IN THE TADANO/FAUN MANUALS - YOU KNOW AND UNDERSTAND LOCAL WORKPLACE RULES AND OSHA RECOMMENDATIONS - AN UNTRAINED OPERATOR SUBJECTS HIMSELF AND OTHERS TO DEATH OR SERIOUS INJURY <p>7757347</p> <p>22,214</p>	 <p>WARNING</p> <p>HAZARD CAN CAUSE INJURY DO NOT MOUNT OR CLIMB ON CRANE WHILE OPERATING</p> <p>7757349</p> <p>81</p>	 <p>WARNING</p> <p>HAZARD CAN CAUSE INJURY DO NOT MOUNT OR CLIMB ON BOOM JIB OR OUTRIGGER</p> <p>7757350</p> <p>157,267</p>	 <p>DANGER</p> <p>80,215</p>

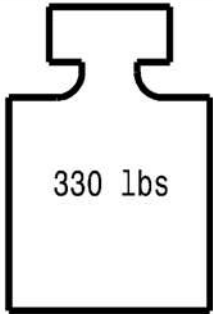
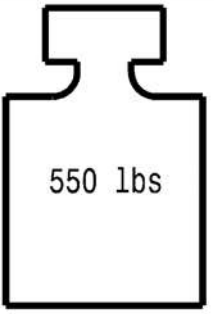









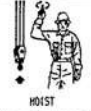











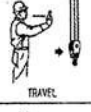







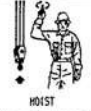











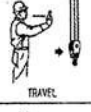







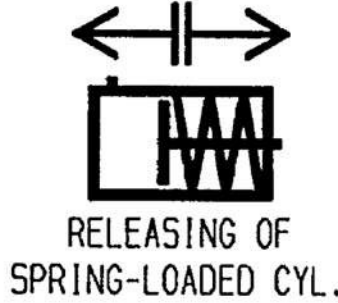
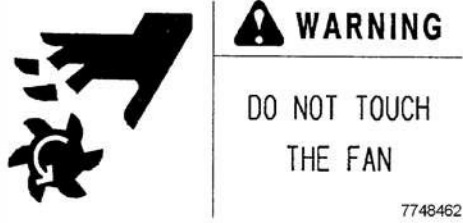
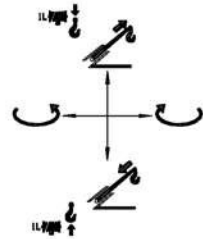
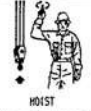









 <p>CAUTION</p> <p>DO NOT STUMBLE OVER PROJECTION</p> <p>7757351</p> <p>82,268</p>	 <p>WARNING</p> <p>DO NOT REMOVE RADIATOR CAP WHEN ENGINE IS HOT.</p> <p>7757352</p> <p>83,269</p>	<p>WARNING</p> <p>HAZARDOUS CONDITION CAN CAUSE SEVERE INJURY DO NOT REMOVE JIB PIVOT PINS AT BOOM HEAD UNTIL JIB IS PINNED TO STOWING BRACKET</p> <p>7757353</p> <p>355</p>	 <p>WARNING</p> <p>AUTOMATIC FAN START KEEP HANDS AWAY STOP ENGINE TO SERVICE</p> <p>7757354</p> <p>84,270</p>
<p>DANGER</p> <p>HAZARDOUS OPERATION CAN RESULT IN SEVERE INJURY OR DEATH. DO NOT LIFT PERSONNEL REFER TO ANSI B30.56-1991, PARA 5-3.2.2 FOR INSTRUCTIONS.</p> <p>7757270</p> <p>216</p>		 <p>271</p>	<p>BUBBLE MUST BE IN THE CENTER (SEE OPERATORS MANUAL)</p> <p>7757298</p> <p>85,217</p>
<p>DANGER</p> <p>HAZARDOUS CONDITION CAN CAUSE SEVERE INJURY OR DEATH STAY CLEAR WHEN INFLATING TIRES ALWAYS USE AN AIR CHUCK AND TIRE CAGE RIM SIDE OR LOCK RING CAN BLOW OUT</p> <p>9920762946</p> <p>79</p>		 <p>330 lbs</p> <p>90</p>	 <p>550 lbs</p> <p>91</p>

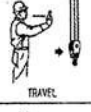

DECAL KIT "USA"
 SCHILDERSATZ "USA"
 JEU DE PLAQUES "USA"

from No / up to No
 WFN5RUG###2036145

Figure
 Bild 99707792831
 Figure

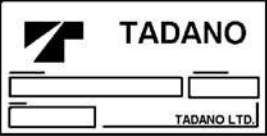
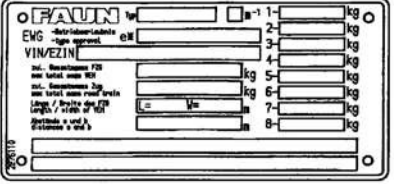
TADANO
 2830-21

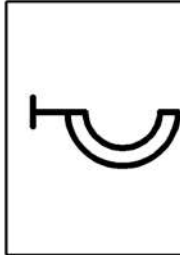
 <p>7757310</p> <p>7757356</p> <p>272</p>	<p>HAND SIGNALS</p> <table border="1"> <tr> <td> HOIST</td> <td> LOWER</td> <td> USE MAIN HOIST</td> <td> USE WHIRLINE (Use Whirly Hoist)</td> </tr> <tr> <td> RAISE BOOM</td> <td> LOWER BOOM</td> <td> MOVE SLOWLY</td> <td> RAISE THE BOOM AND LOWER THE LOAD</td> </tr> <tr> <td> LOWER THE BOOM AND RAISE THE LOAD</td> <td> SWING</td> <td> STOP</td> <td> EMERGENCY STOP</td> </tr> <tr> <td> TRAVEL</td> <td> DOGS EVERYTHING</td> <td> TRAVEL (2 BOOM TRUCKS)</td> <td> TRAVEL (1 BOOM TRUCK)</td> </tr> <tr> <td> EXTEND BOOM</td> <td> RETRACT BOOM</td> <td> EXTEND BOOM (2 BOOM TRUCKS)</td> <td> RETRACT BOOM (2 BOOM TRUCKS)</td> </tr> </table> <p>7741365</p> <p>87</p> <p>86,218,273</p>	 HOIST	 LOWER	 USE MAIN HOIST	 USE WHIRLINE (Use Whirly Hoist)	 RAISE BOOM	 LOWER BOOM	 MOVE SLOWLY	 RAISE THE BOOM AND LOWER THE LOAD	 LOWER THE BOOM AND RAISE THE LOAD	 SWING	 STOP	 EMERGENCY STOP	 TRAVEL	 DOGS EVERYTHING	 TRAVEL (2 BOOM TRUCKS)	 TRAVEL (1 BOOM TRUCK)	 EXTEND BOOM	 RETRACT BOOM	 EXTEND BOOM (2 BOOM TRUCKS)	 RETRACT BOOM (2 BOOM TRUCKS)	 <p>7741365</p> <p>RELEASING OF SPRING-LOADED CYL.</p> <p>87</p>  <p>WARNING</p> <p>DO NOT TOUCH THE FAN</p> <p>7748462</p> <p>219</p>	<p>140°F ———</p> <p>104°F ———</p> <p>68°F ———</p> <p>32°F ———</p> <p>7741388</p> <p>88,274</p> <p>9970777801</p>  <p>213</p>
 HOIST	 LOWER	 USE MAIN HOIST	 USE WHIRLINE (Use Whirly Hoist)																				
 RAISE BOOM	 LOWER BOOM	 MOVE SLOWLY	 RAISE THE BOOM AND LOWER THE LOAD																				
 LOWER THE BOOM AND RAISE THE LOAD	 SWING	 STOP	 EMERGENCY STOP																				
 TRAVEL	 DOGS EVERYTHING	 TRAVEL (2 BOOM TRUCKS)	 TRAVEL (1 BOOM TRUCK)																				
 EXTEND BOOM	 RETRACT BOOM	 EXTEND BOOM (2 BOOM TRUCKS)	 RETRACT BOOM (2 BOOM TRUCKS)																				
 <p>69</p> <p>7757223</p>	<p>512,513</p>  <p>514,515</p> 																						

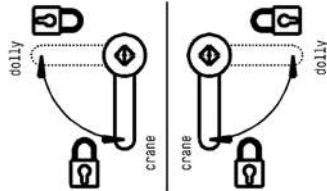
<p style="text-align: center;">403</p> <div style="border: 1px solid black; padding: 5px; display: flex; align-items: center;">  <div style="text-align: center;"> <p>BRAKE PRESSURE MAX: 123 PSI</p> </div> </div>	<p style="text-align: center;">404</p> <div style="border: 1px solid black; padding: 5px; display: flex; align-items: center;">  <div style="text-align: center;"> <p>RESERVOIR PRESSURE MAX: 123 PSI</p> </div> </div>	<p style="text-align: center;">401</p> <div style="border: 1px solid black; padding: 10px; text-align: center; width: 100px; margin: 0 auto;"> <p>24V / DC</p> </div>
<p style="text-align: center;">402</p> <div style="border: 1px solid black; padding: 5px; display: flex; align-items: center;">  <div style="text-align: center;"> <p>ANTI-LOCK SYSTEM 24V / DC</p> </div> </div>	<p style="text-align: center;">405, 451</p> <div style="border: 1px solid black; padding: 5px;"> <p style="text-align: center;"> DANGER</p> <p style="text-align: center; font-size: small;">ERRONEOUS LEVER POSITION CAN CAUSE SERIOUS ACCIDENT. DO NOT TRAVEL OR OPERATE CRANE WITH WRONG SETTING.</p> <ul style="list-style-type: none"> • DOLLY TRAVEL: LOCK LEVER IN DOLLY POSITION. REMOVE SWING LOCK PIN. • CRANE OPERATION: LOCK LEVER IN CRANE POSITION. • SEE OPERATORS MANUAL FOR INSTRUCTIONS. </div>	<p style="text-align: center;">406, 452</p> 

DECAL KIT "USA"
SCHILDERSATZ "USA"
JEU DE PLAQUES "USA"

from No / up to No
WFN5RUG###2036145

Figure
Bild 99707792831
Figure

 **TADANO**
2830-21

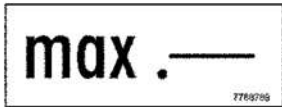
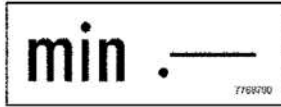
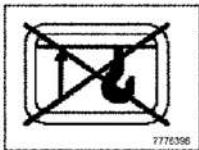
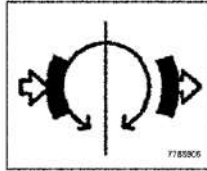
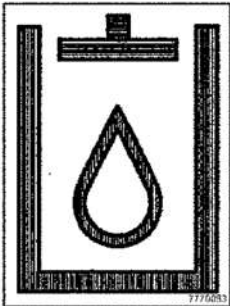
 <p>275</p>	 <p>276</p>	 <p>277</p>
 <p>223</p>		 <p>222</p>
 <p>224</p>		

DECAL KIT "USA"
 SCHILDERSATZ "USA"
 JEU DE PLAQUES "USA"

from No / up to No
 WFN5RUG###2036145

Figure
 Bild 99707792831
 Figure

TADANO
 2830-21

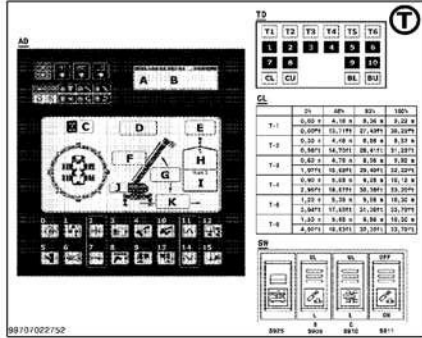

550

SPEED - CHART

Tires 16.00R25 / 20.5R25

Gear	Off-Road		On-Road	
	mph	km/h	mph	km/h
1 st	2	3	4	6
2 nd	2	3	4	7
3 rd	2	4	5	8
4 th	2	4	6	10
5 th	3	5	7	12
6 th	4	7	9	15
7 th	5	8	11	18
8 th	6	9	13	21
9 th	7	11	16	26
10 th	9	14	19	31
11 th	11	17	24	38
12 th	12	20	29	46
13 th	15	24	35	56
14 th	19	30	42	68
15 th	22	35	50	80
16 th	26	42	53	85
1 st RW	2	3	4	6
2 nd RW	2	3	4	7

DO NOT RUN THE ENGINE OVER 2000 rpm

99707785935

0°TILT 20°TILT 40°TILT

351

MAX. JACK FORCE
 DURING CRANE
 OPERATION:
132 TONS (US)

153

27.23 ft

161

18.37 ft

162

19